



***Maximise your Business***

***joining our Franchising Programme***



***Franchising Profile***



# FRANCHISING

## What is the Franchise Agreement?

Its an arrangement where one party (the franchiser) grants another party (the franchisee) the right to use its trademark as well as certain business systems and processes to market the goods and services according to certain specifications.

The franchisee will gains:

- (1) Immediate name recognition,
- (2) Tried and tested products,
- (3) Standard design and decor,
- (4) Detailed techniques in running and promoting the business,
- (5) Training of employees
- (6) Ongoing help in promoting and upgrading of the products.

In additional to above PETROL ONE has created a new Franchising concept with full resource of supporting chain.

Starting from manufacturing to last step as a LUBE sale point station ( AS WHEREVER YOU ARE) to guarantee NO one can compete with your business, if you are interested Please fill up the application

- Low Capital.
- High Income.
- Short return investment.
- High and International brand.
- Luxury image.
- Flexible movement.

To apply as a franchisor or franchisee please fill up the application form at  
[www.petrol-one.com/franchise.html](http://www.petrol-one.com/franchise.html)



# Portable Oil Station

## Portable P120

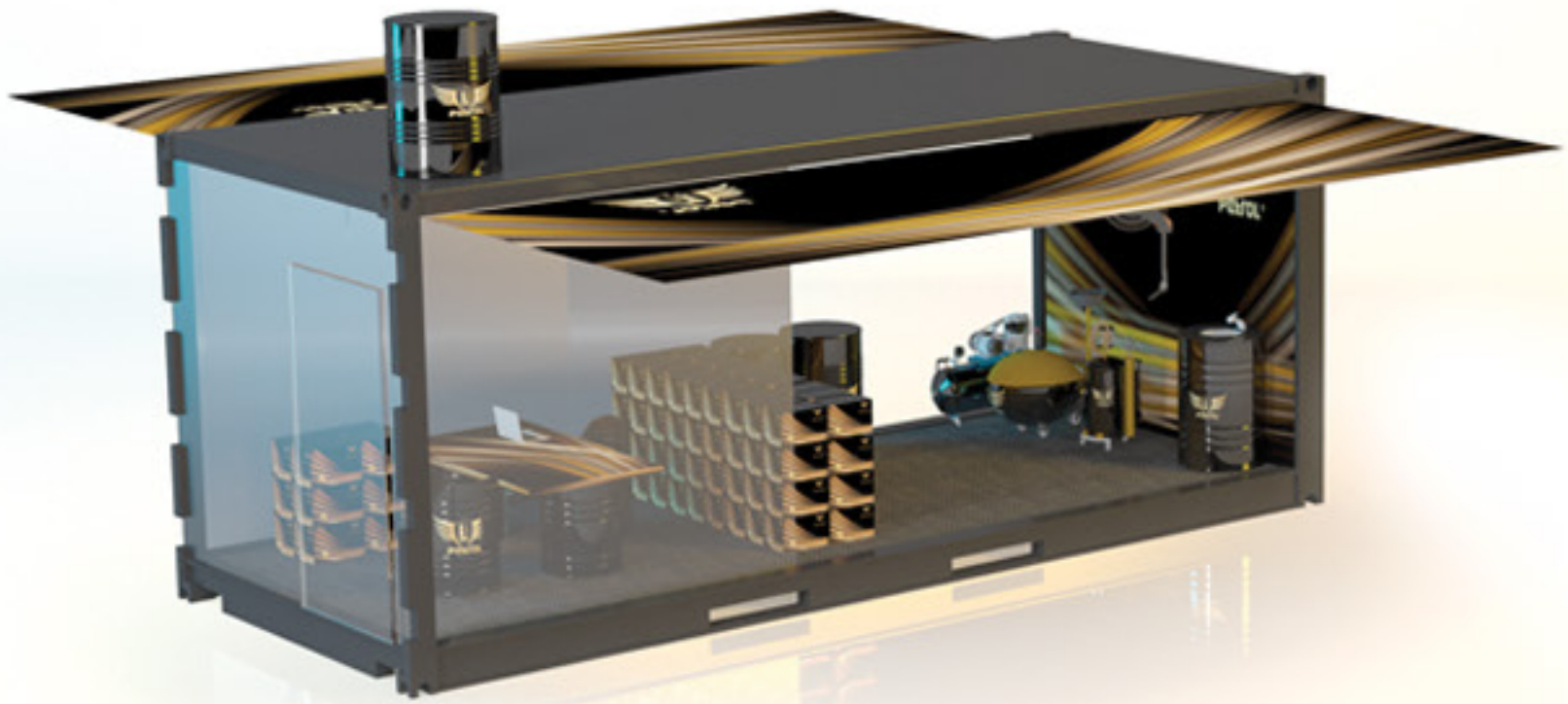

A new concept of oil changing station with all in one place with integrated machinery and cutting edge technology to fulfill your car needs in one place. The Oil Station comes in two options.

1. A fully functional single station with 20 feet container area fixed with all necessary items.
2. A fully functional station with 40 feet container area with more storage space and working area supplied with all machinery.

## Approval Certificate



## Portable P140

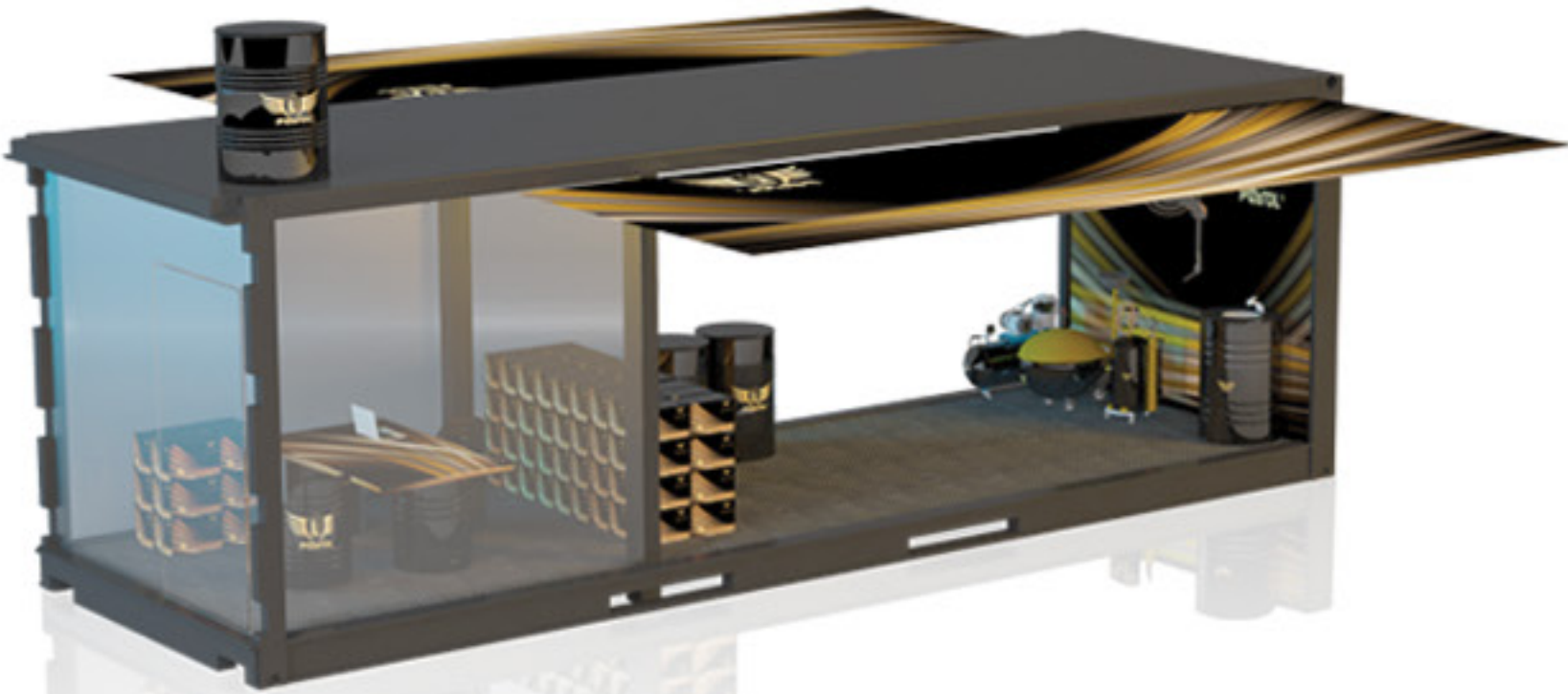

### Features:-

- CSC Safety Approved high grade steel container.
- Light weight Aluminium wings shaped door.
- Low power Consuming bright Led lights.
- Removable high grade 10mm glass panels.
- Reinforced steel flooring for extra durability.



# Portable P120

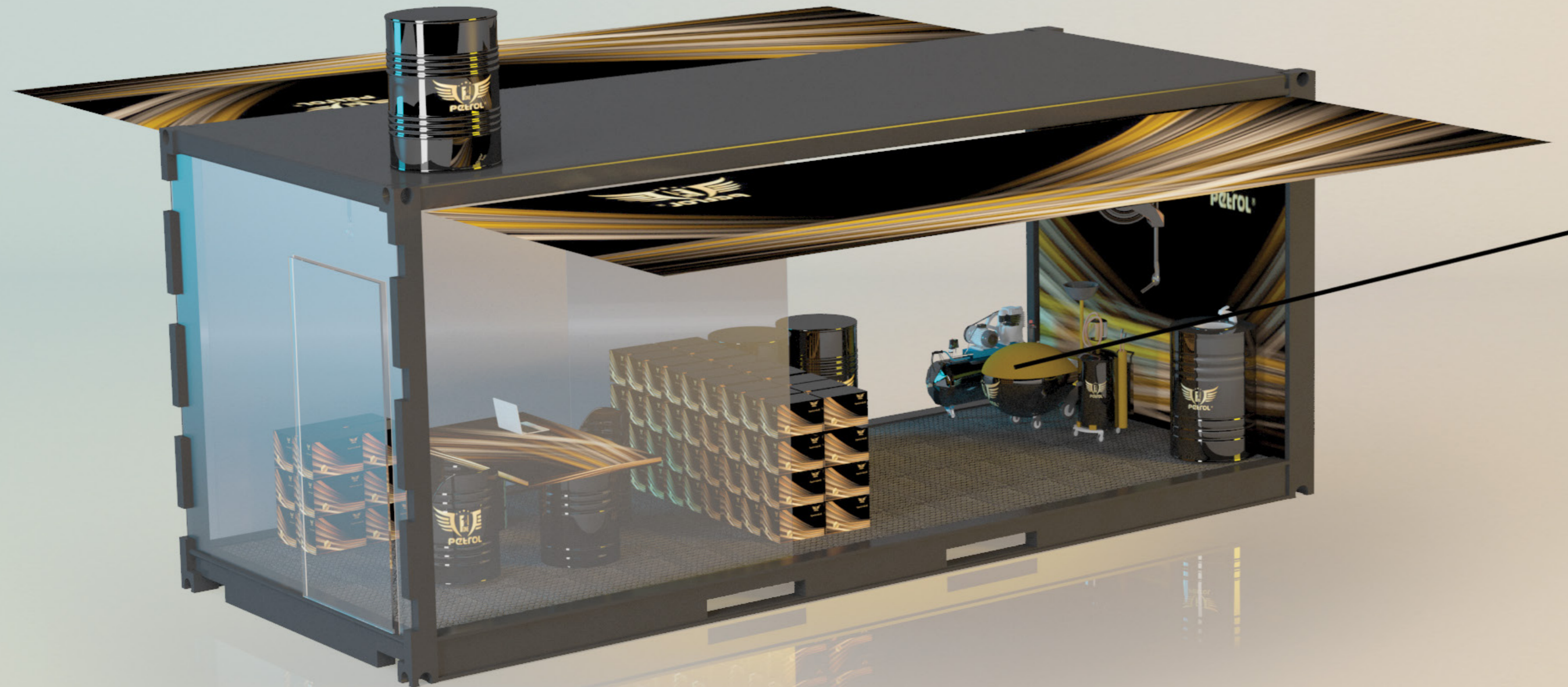

## Tools and Wash Trolley

Tools and wash an environmentally friendly, equipped with electrical pump and waterless car wash powered by rechargeable battery works flawlessly and effectively, providing you with the space to carry all the necessary elements required in car care services.

## Specifications

Comes with necessary tools for oil change and minor car works.  
Compact and all-in-one auto detailing car wash system and tools.  
Pump Type are electrical with rechargeable battery.  
Wash 15+ cars per day.  
Consumes less than 4 litres per wash.  
High Reach Lance; pressure Nozzle.  
Trolley Weight when empty: 115 kg.  
100 % natural and soluble cleaning agents.

Quantity 1

Size 65x120x100 cm

Material Fiberglass

Color Black and Gold





# Portable P120

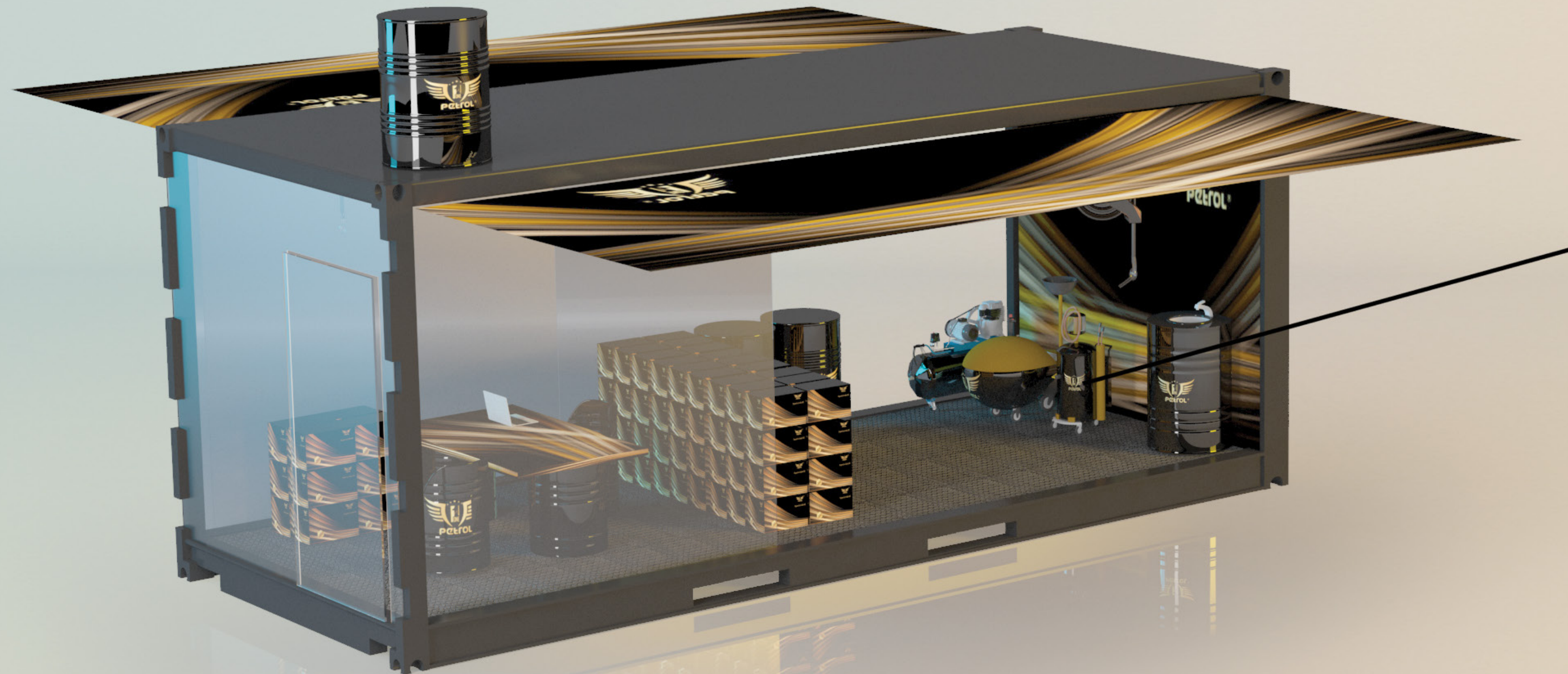

## Pneumatic Waste Oil Collector / Oil drainer

Multi-function:oil sucking, oil collecting & oil filling machine. Made form high grade materials. Convenient to move with the universal wheels. Additional large oil tray for oil collecting and easy use to drain oil in low pressure. Transparent measuring cup for easy oil observation and comes Different type of nozzles for various condition.

## Specifications

Quantity	1
Size	50 x 40 x 90 cm
Material	Metal
Color	Black





# Portable P120

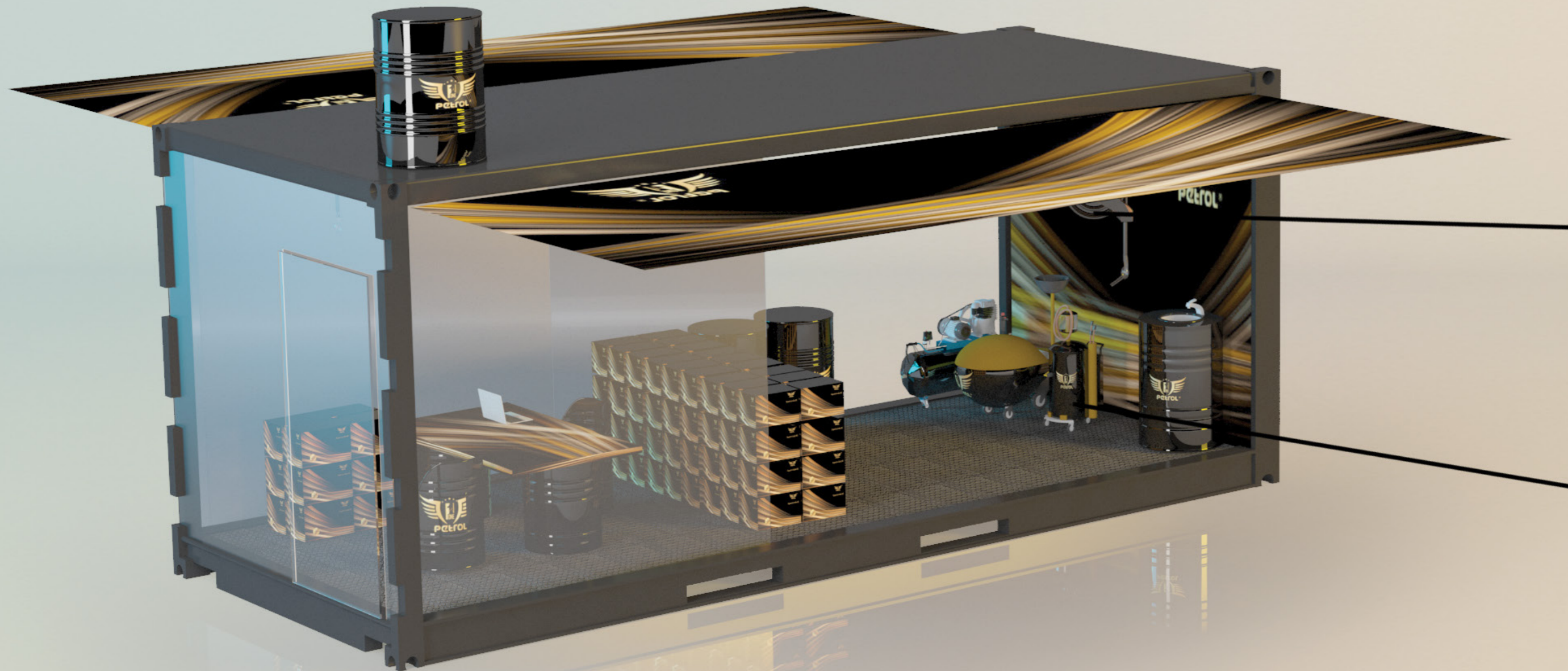

## Air Hose Reel

Full metal heavy-duty double pedestal air hose reel, with hose capacity up to 50' x 1/2" hose. Applicable for blowing dust, cleaning car parts and other works. Self-retracting reel keeps hose neatly out of sight. Delivered in ceiling mount position



## Specifications

Quantity	1
Size	50 x 20 x 65 cm
Material	Aluminium
Color	Black

## Industrial Air Compressor

Heavy Duty industrial air compressor with 1.8 horsepower 4-pole induction motor with two oil less pumps for quiet running 2x longer life, and less maintenance, Integrated control panel with two gauges, a regulator and two quick couplers for easy operation. With multiple self protection system to ensure equipment and personal safety. Pure air flow. Oil free design, no lubrication oil needed during operation.

## Specifications

Quantity	1
Size	50 x 40 x 90 cm
Material	Metal
Color	Black

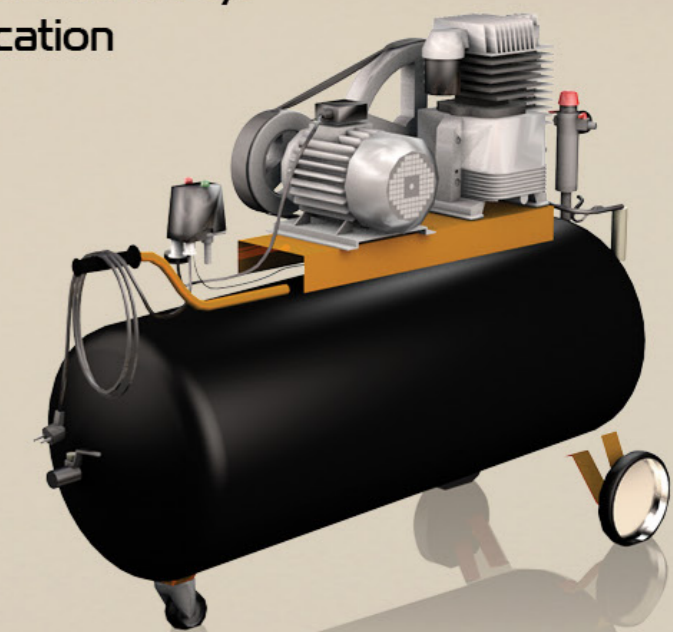



# Portable P120

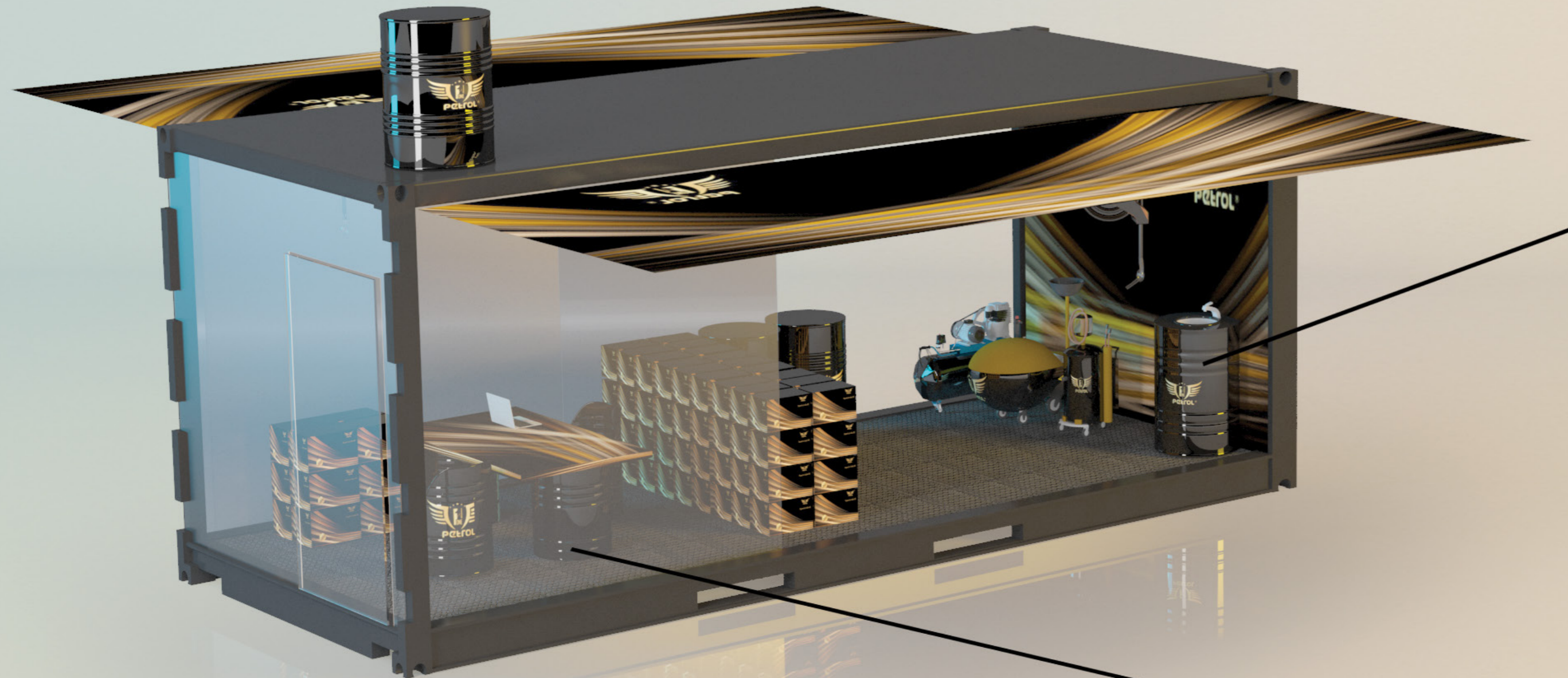

## Hand wash basin

Hand wash basin built from High Grade steel Drum with built in drainage system with fancy drum style and faucet.

### Specifications

Quantity	1
Size	58 x 85 cm
Material	Steel
Color	Black



## Office

Fully Equipped office with 3 side glasses and rest area for managing staff and customer. Air conditioned room and comfortable chairs along with office table.

### Specifications

Quantity	1
Size	58 x 85 cm
Material	Glass and steel
Color	Variable



# Portable P120

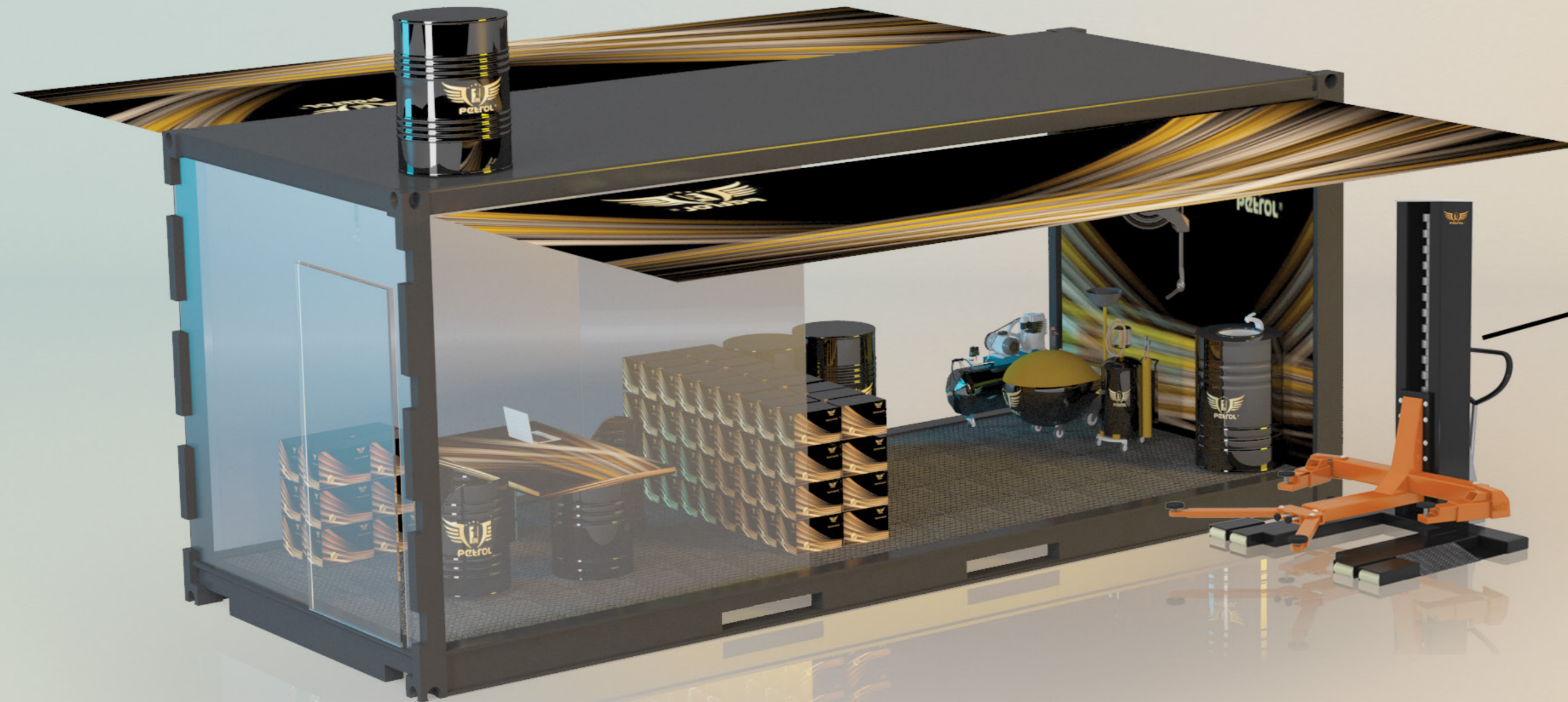

## Movable Single Post Car Lift

Totally mobile single post car lift for outdoor and indoor use. With carrying capacity of 2.7 ton and lifting height of 1800 mm. Its made of durable and long lasting metal with integrated operating panel and emergency stop switch. The car lift is electromechanical, built-in style. these feature result in a large carrying capacity.

## Specifications

Quantity	1
Size	700 x 900 x 1500 mm
Material	Metal
Color	Black and Golden

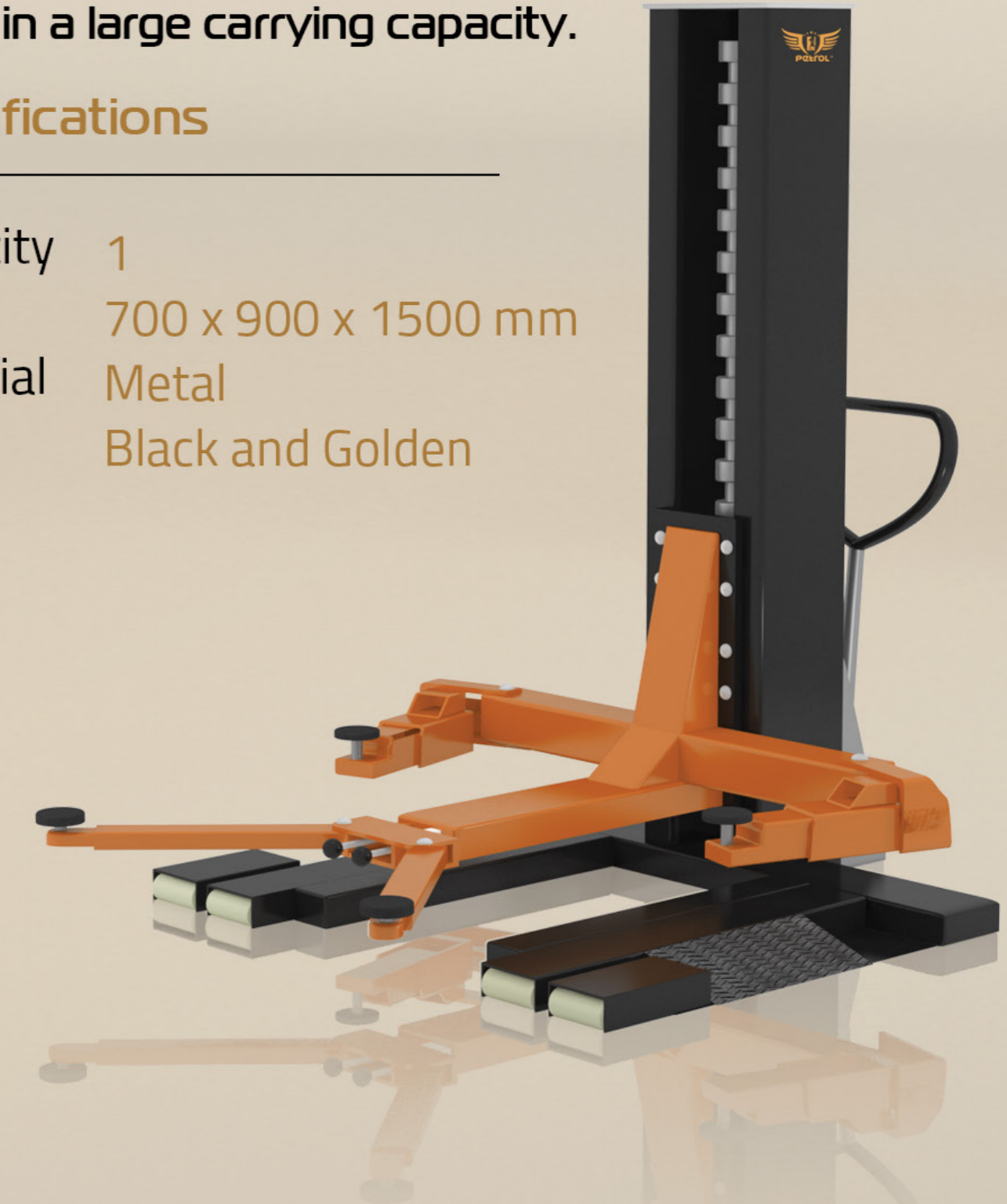



# Portable P120

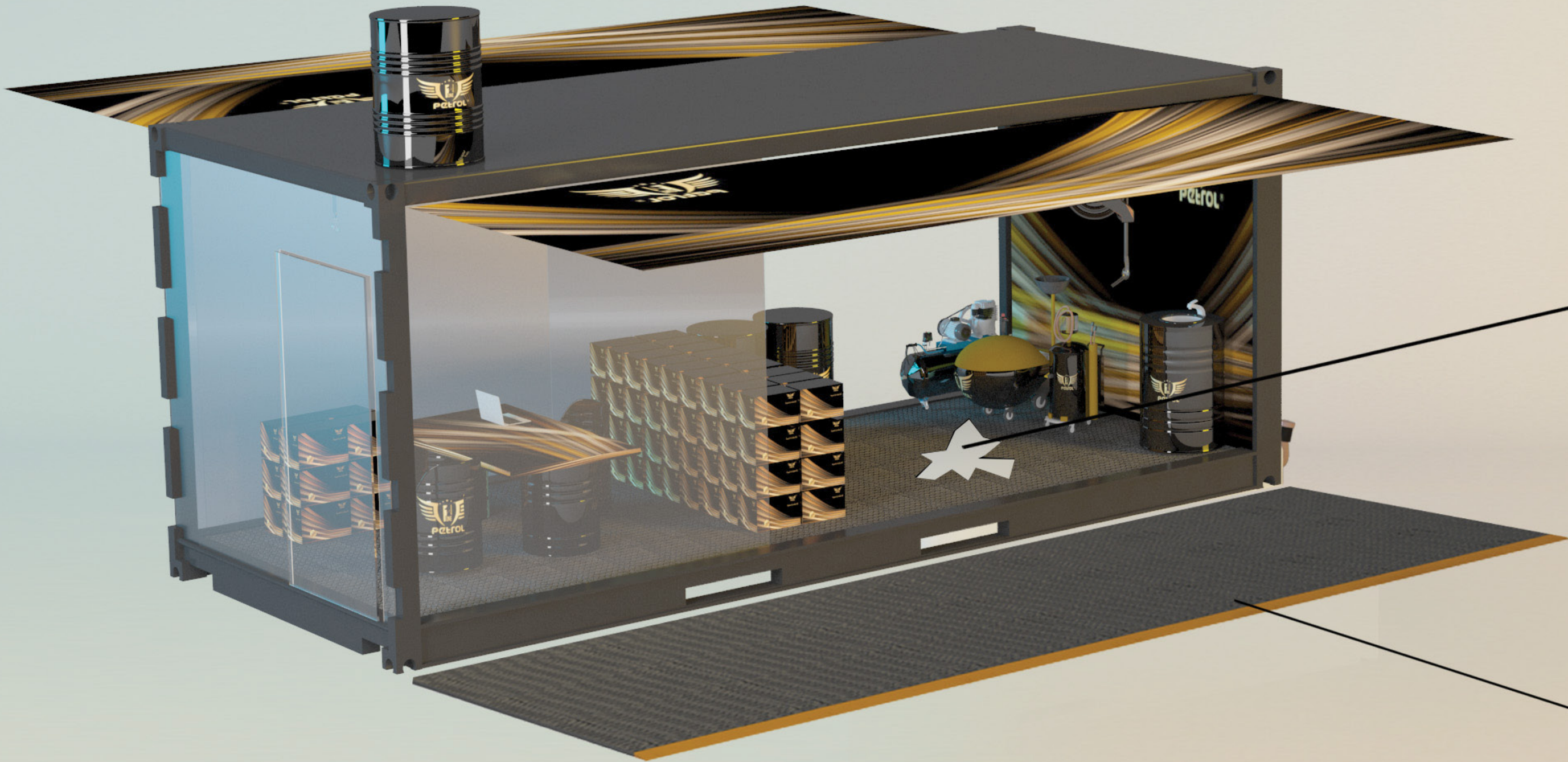

## Waste oil collection tank

High grade and durable storage tank made of rust proof steel. For storing waste oil and has a direct inlet connection to tank for easy waste oil pouring. it has a lockable lid to avoid spillages. The material grade has good impact, mechanical and stress crack resistance properties. Sure and efficient oil storage for commercial properties. Installed under the container floor.

## Specifications

- Quantity 2
- Size 30 x 96 x 5 Inch
- Material steel
- Color White



## Interlocking Floor Tiles

High grade and durable faux tiles made of Polypropylene. Felxible and easy to fit install on the floor. The tiles are tileable so can be fixed on site and can be moved when ever needed. These tiles keep the floor neat and tidy and easy to clean Installed infront of container floor.

## Specifications

- Quantity 1
- Size 6.09 x 2.5 Meter
- Material Polypropylene
- Color Black and Gold

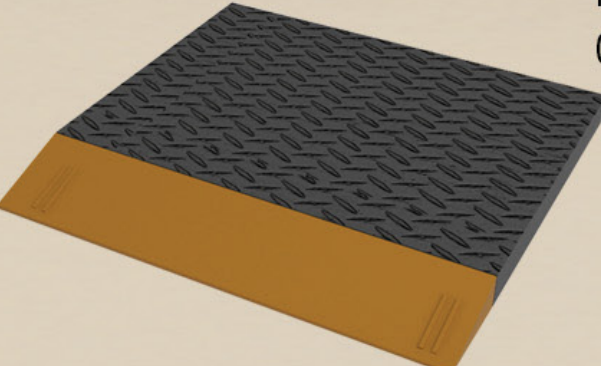









# 1 Quickbooks Accounting Features

- 

**Cloud Accounting**  
Access your account, manage your business, and stay organized anytime, anywhere on your computer, mobile or tablet.
- 

**Expense Tracking**  
Record expenses for tax time. You can even photograph and save receipts with the QuickBooks Online mobile app.
- 

**Invoicing**  
Create custom, professional invoices, sales receipts and estimates that you can send in minutes.
- 

**Accounting Reports**  
Instantly see how your business is performing with customizable reports and dashboards.
- 

**Cash Flow Management**  
Enter bills from vendors, and pay them only when they are due. Schedule recurring payments to save time.
- 

**Accountant access**  
Your accountant can manage your records from anywhere, anytime making it easy to work together.
- 

**Automatic backups**  
QuickBooks Online backs up your data every day, so your figures are always up-to-date.<sup>1</sup>
- 

**Data security**  
Bank level security (128-bit SSL encryption) ensures your data is safe.<sup>4</sup>
- 

**Free unlimited support**  
If you need help, support is available Monday to Friday 7.00 am - 12.00 am (GMT+8).<sup>1</sup>

# 2 Petrol One Application

Our application is designed to provide details about the vehicle's oil specification and details like the oil grade recommended for the specific engine Lube oil and capacity.

# 3 Wire-free printing

Experience the ultimate in portability and is the ultimate companion for portable and stylish printing from smartphones, tablets and the cloud works seamlessly with the quickbooks application.

# 4 Multitouch Tablet

Advance features with high speed processor and dazzling display helps you to do multi task without slowing your workflow. Powered by rechargeable battery to give you mobility and direct dc power for longer usage.



Hardware and Software are included





# Petrol One Premium Class Lubricants

PETROL ONE LUBRICANTS produced from highest quality base oil and advanced technology additives to give the optimum performance and long lasting protection for engines in all conditions.

Petrol-One Lubricants are produced to give optimum performance along with protection for engine parts increasing engine life and good value for money with long drain intervals and keeps engine clean from sludge and corrosion..



CERTIFIED BY



APPROVED BY OEM



Sponsor







[WWW.PETROL-ONE.COM](http://WWW.PETROL-ONE.COM)